

DS-2CE16D8T-IT 2 MP Ultra Low-Light EXIR Bullet Camera



Key Features

- 2.0 megapixel high-performance CMOS
- HD analog output, up to 1080p resolution
- 2.8 mm, 3.6 mm, 6 mm fixed focal lens
- True Day/Night
- 120 dB true WDR
- OSD menu, DNR, Smart IR
- EXIR 2.0, up to 20 m IR distance
- IP67
- Up the Coax (HIKVISION-C)



Specification

| Camera | |
|----------------------------------|--|
| Image Sensor | 2.0 megapixel progressive scan CMOS |
| Signal System | PAL/NTSC |
| Frame Rate | PAL: 1080p@25fps NTSC: 1080p@30fps |
| Resolution | 1920 (H) × 1080 (V) |
| Min. illumination | Color: 0.005 Lux @ (F1.2, AGC ON), 0 Lux with IR |
| Shutter Time | PAL: 1/25 s to 1/50, 000 s NTSC: 1/30 s to 1/50, 000 s |
| Slow Shutter | Max.: 16 times |
| Lens | 2.8 mm, 3.6 mm, 6 mm fixed focal lens |
| Horizontal Field of View | 103.5° (2.8 mm), 82.6° (3.6 mm), 54.4° (6 mm) |
| Lens Mount | M12 |
| Day & Night | IR cut filter |
| Angle Adjustment | Pan: 0° to 360°, Tilt: 0° to 90°, Rotate: 0° to 360° |
| Synchronization | Internal synchronization |
| WDR (Wide Dynamic Range) | > 120 dB |
| Menu | |
| AGC | Support |
| Day/Night Mode | Auto/Color/BW (Black and White) |
| White Balance | ATW/MANUAL |
| Privacy Mask | ON/OFF, 4 programmable privacy masks |
| Motion Detection | 4 programmable motion areas |
| Backlight Compensation | WDR/BLC/HLC/OFF |
| 3D DNR (Digital Noise Reduction) | On |
| Language | English, Chinese |
| Functions | Brightness, Sharpness, Mirror, Smart IR |
| Interface | |
| Video Output | 1 HD analog output |
| General | |
| Operating Conditions | -40 °C to 60 °C (-40 °F to 140 °F), humidity: 90% or less (non-condensation) |
| Power Supply | 12 VDC ± 25% |
| Power Consumption | Max. 4W |
| Ingress Protection | IP67 |
| Material | Metal |
| IR Range | Up to 20 m |
| Communication | Up the coax, Protocol: HIKVISION-C (TVI output) |
| Dimensions | 58 mm × 61 mm × 163 mm (2.28" × 2.40" × 6.42") |
| Weight | Approx. 350 g (0.77 lb.) |

Order Models

DS-2CE16D8T-IT

Dimension

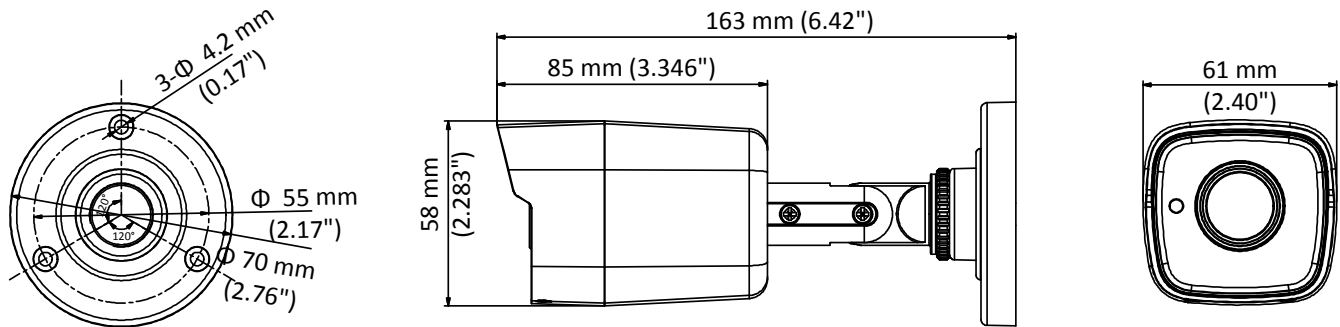

Accessory



DS-1280ZJ-XS
Junction Box



DS-1H18
Video Balun

Distributed by



HIKVISION

Headquarters

No.555 Qianmo Road, Binjiang District,
Hangzhou 310051, China
T +86-571-8807-5998
overseasbusiness@hikvision.com

Hikvision USA
T +1-909-895-0400
sales.usa@hikvision.com

Hikvision Europe
T +31-23-55-42-770
info.eu@hikvision.com

Hikvision Middle East
T +971-4-8816086
salesme@hikvision.com

Hikvision Russia
T +7-495-669-67-99
saleru@hikvision.com

Hikvision India
T +91-22-28469900
sales@pramahikvision.com

Hikvision Italy
T +39-0438-6902
info.it@hikvision.com

Hikvision France
T +33(0)1-85-330-450
info.fr@hikvision.com

Hikvision Spain
T +34-91-737-16-55
info.es@hikvision.com

Hikvision Poland
T +48-22-460-01-50
poland@hikvision.com

Hikvision UK
T +01628-902140
support.uk@hikvision.com

Hikvision Singapore
T +65-6684-4718
sg@hikvision.com

Hikvision Oceania
T +61-2-8599-4233
salesau@hikvision.com

Hikvision Canada
T +1-909-895-0400
sales.usa@hikvision.com

Hikvision Korea
T +82-31-731-8841
sales.korea@hikvision.com

Hikvision Brazil
T +55 11 3318-0050
Latam.support@hikvision.com

Hikvision Africa
T +27 (0) 0351172
sale.africa@hikvision.com

Hikvision Hong Kong
T +852-2151-1761